



ORIENT

Photocoupler

Product Data Sheet

Name: MOC305X

Customer: _____

Date: _____

1. Features

- (1) Isolation voltage between input and output Viso : 5,000V rms
- (2) 6pin non zero-cross optoisolators triac driver output
- (3) High repetitive peak off-state voltage VDRM : Min. 600V
- (4) High critical rate of rise of off-state voltage(dV/dt : MIN. 1000V / s)
- (5) Dual-in-line package : MOC3050, MOC3051, MOC3052, MOC3053
- (6) Wide lead spacing package : MOC3050M, MOC3051M, MOC3052M,MOC3053M
- (7) Surface mounting package : MOC3050S, MOC3051S, MOC3052S, MOC3053S
- (8) Tape and reel packaging : MOC3050S-TA, MOC3051S-TA, MOC3052S-TA, MOC3053S-TA,MOC3050S-TA1, MOC3051S-TA1, MOC3052S-TA1, MOC3053S-TA1

2. Description

The MOC305X consists of a non zero crossing photo triac, optically coupled to a gallium arsenide infrared emitting diode. The MOC305X is housed in the DIP6 package and guarantees insulation thickness. Therefore, the MOC305X meets the reinforced insulation class requirements of international safety standards.

3. Application Range

- AC Motor Drives
- AC Motor Starters
- Static power switch
- Lighting Controls
- Solenoid/Valve Controls
- Solid State Relays
- Temperature Controls

4. Absolute Maximum Ratings (Ta=25°C)

Parameter		Symbol	Rated Value	Unit
Input	Forward Current	I _F	50	mA
	Junction Temperature	T _J	125	°C
	Reverse Voltage	V _R	6	V
	Power Dissipation	P	100	mW
Output	Off-State Output Terminal Voltage	V _{DRM}	600	V
	Peak Repetitive Surge Current (PW=1ms, 120 pps)	I _{TSM}	1	A
	Junction Temperature	T _J	125	°C
	Collector Power Dissipation	P _C	300	mW
Total Power Dissipation		P _{tot}	330	mW
*1 Insulation Voltage		V _{iso}	5000	Vrms
Working Temperature		Topr	-40 ~ + 100	°C
Deposit Temperature		T _{stg}	-55 ~ + 150	
*2 Soldering Temperature		T _{sol}	260	

Notes:

*1 AC for 1 minute, R.H.= 40 ~ 60% R.H. In this test, pins 1, 2&3 are shorted together, and pins 4, 6 are shorted together.

* 2 For 10 seconds

5.Electrical Optical Characteristics at Ta=25°C

Parameter		Symbol	Condition	Min	Typ.*	Max	Unit	
Input	Forward Voltage	V_F	$I_F=20mA$	---	1.2	1.6	V	
	Reverse Current	I_R	$V_R=6V$	---	0.05	10	μA	
Output	1.Peak Blocking Current, Either Direction	I_{DRM}	$V_{DRM} = 600V$	---	10	100	nA	
	Peak On-State Voltage, Either Direction	V_{TM}	$I_{TM}=100mA$ Peak	---	1.7	3.0	V	
	2.Critical rate of Rise of Off-State Voltage	dv/dt	$V_{in}=240V_{rms}$	1000	---	---	V/us	
Couple	3.Led Trigger Current,Current Required to Latch Output, Either Direction	MOC3050	I_{FT}	Main Terminal Voltage = 3V	---	---	30	mA
		MOC3051			---	---	15	
		MOC3052			---	---	10	
		MOC3053			---	---	5	
	Holding Current, Either Direction	I_H		---	200	---	μA	

*1. Test voltage must be applied within dv/dt rating.

*2. This is static dv/dt. Commutating dv/dt is a function of the load-driving thyristor(s) only.

*3. All devices are guaranteed to trigger at an I_F value less than or equal to max I_{FT} .

Therefore, recommended operating I_F lies between max I_{FT} , 30 mA for MOC3050, 15 mA for MOC3051, 10 mA for MOC3052, 5 mA for MOC3053, and absolute max I_F (50mA).

6.Naming Rule

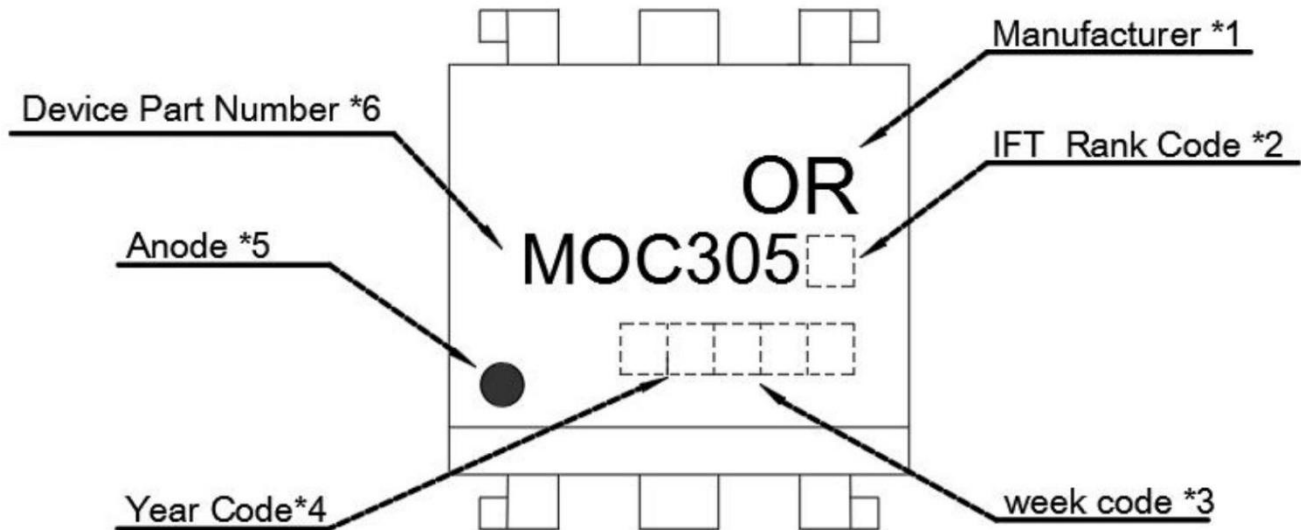

NOTE :

- (1) Manufacturer denotes Shenzhen Orient Tech Ltd . Co ., Ltd.
- (2) denotes IFT Rank Code ,0=MOC3050; 1=MOC3051; 2=MOC3052; 3=MOC3053.
- (3) denotes Week code.
- (4) denotes Year code.
- (5) ● denotes Anode.
- (6) MOC305 denotes Device Part Number.
- (7) Unit:mm

7. Package Dimension

(1). MOC305X

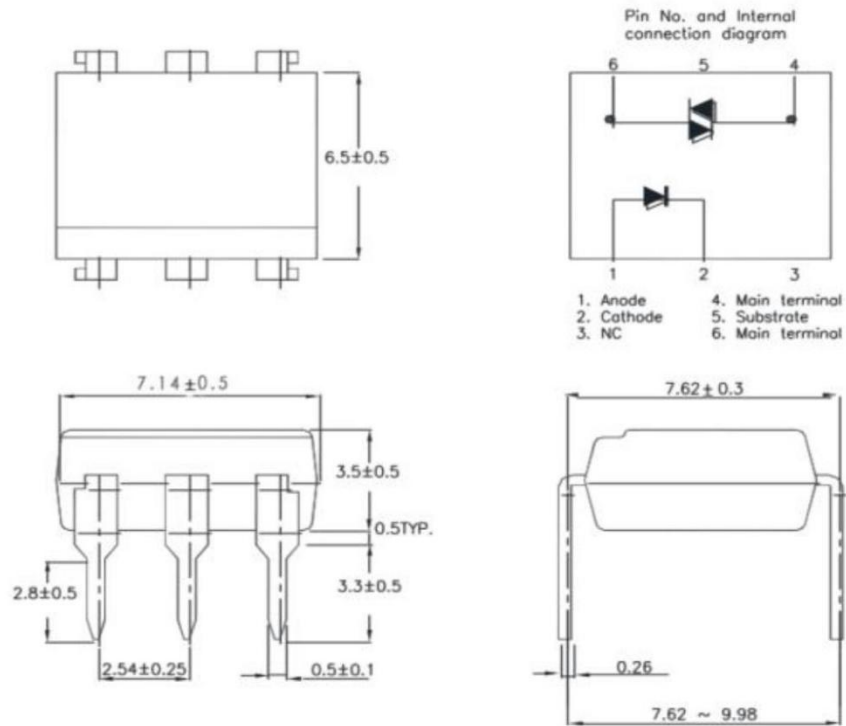

(2). MOC305X M

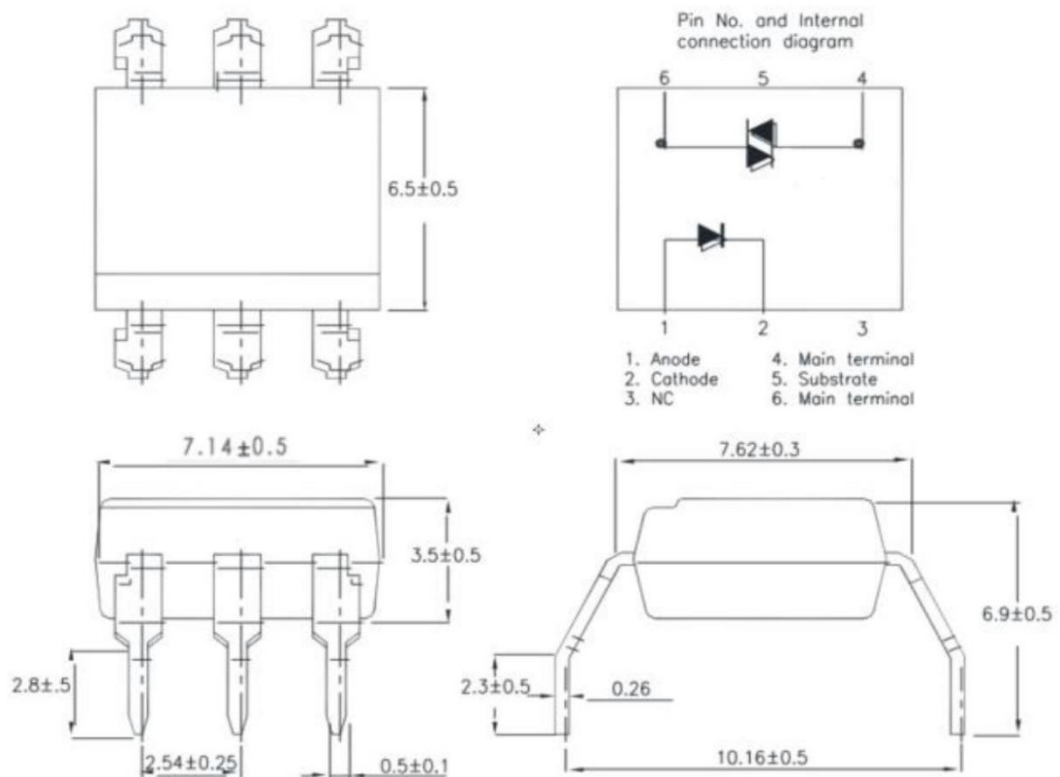

(3). MOC305X S

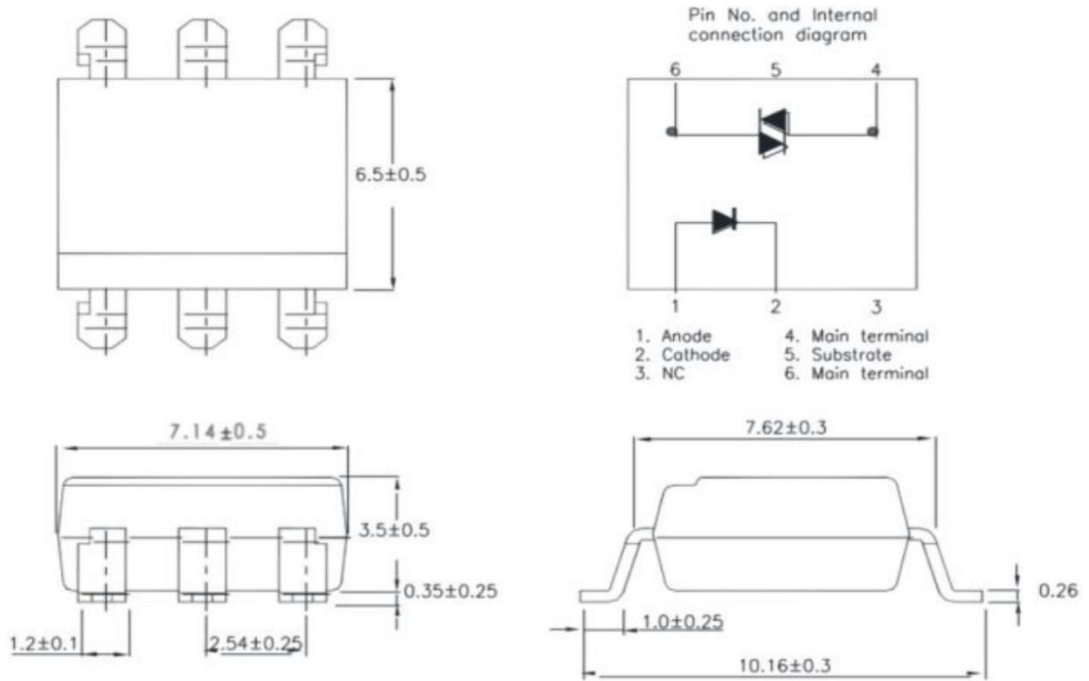

8. Taping Dimensions

(1). MOC305XS-TA

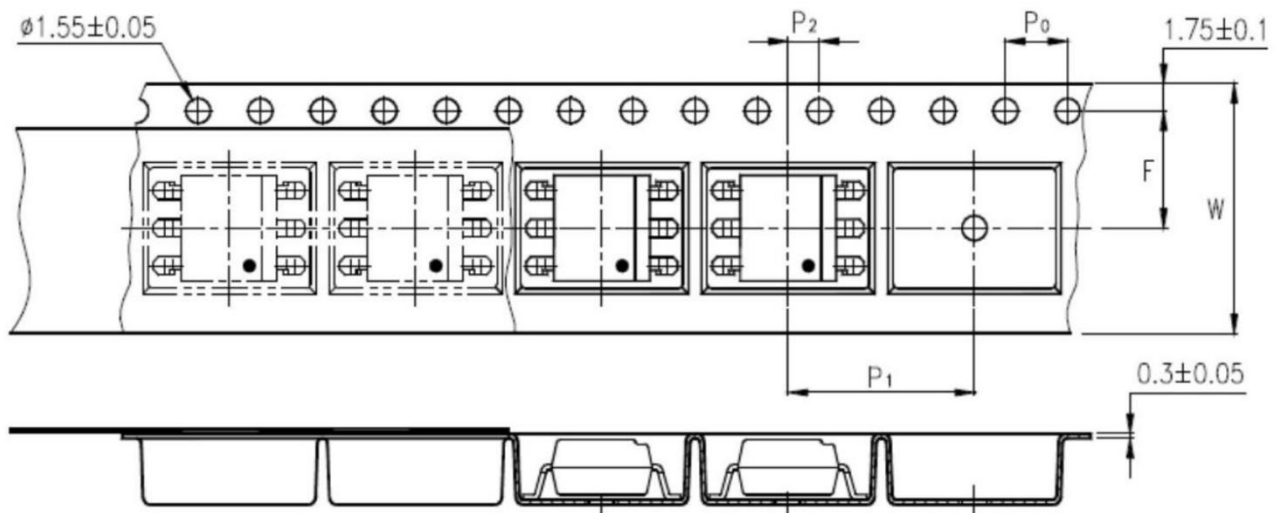

2. MOC305XS-TA1

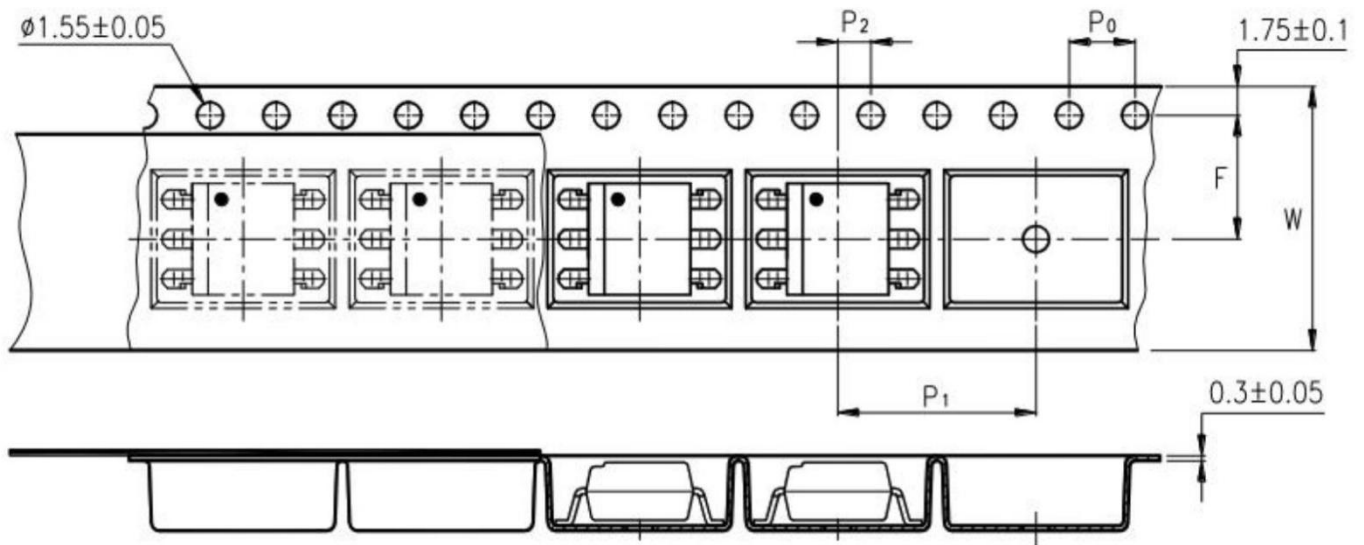

Description	Symbol	Dimension in mm (inch)
Tape wide	W	16±0.3 (0.63)
Pitch of sprocket holes	P ₀	4±0.1 (0.15)
Distance of compartment	F	7.5±0.1 (0.295)
	P ₂	2±0.1 (0.079)
Distance of compartment to compartment	P ₁	12±0.1 (0.472)

Package Type	MOC305XS series (TA/TA1)
Quantities(pcs)	1000

9. Temperature Profile Of Soldering

(1).IR Reflow soldering (JEDEC-STD-020C compliant)

One time soldering reflow is recommended within the condition of temperature and time profile shown below. Do not solder more than three times.

Profile item	Conditions
Preheat	
- Temperature Min (T_{Smin})	150°C
- Temperature Max (T_{Smax})	200°C
- Time (min to max) (t_s)	90±30 sec
Soldering zone	
- Temperature (T_L)	217°C
- Time (t_L)	60 sec
Peak Temperature(T_P)	260°C
Ramp-up rate	3°C / sec max.
Ramp-down rate	3~6°C / sec

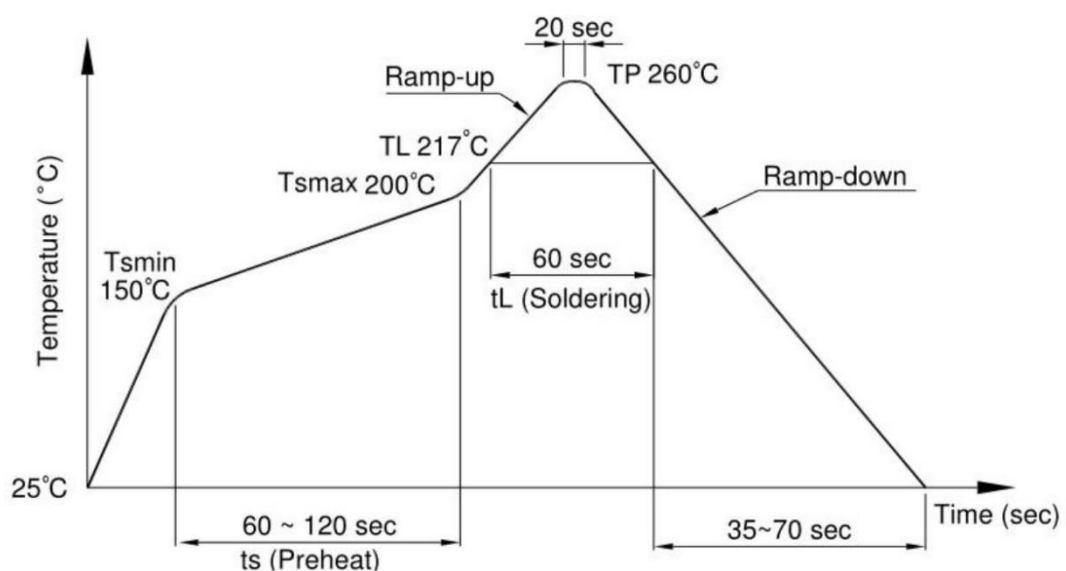

(2) .Wave soldering (JEDEC22A111 compliant)

One time soldering is recommended within the condition of temperature.

Temperature	260+0/-5°C
Time	10 sec
Preheat temperature	5 to 140°C
Preheat time	30 to 80 sec

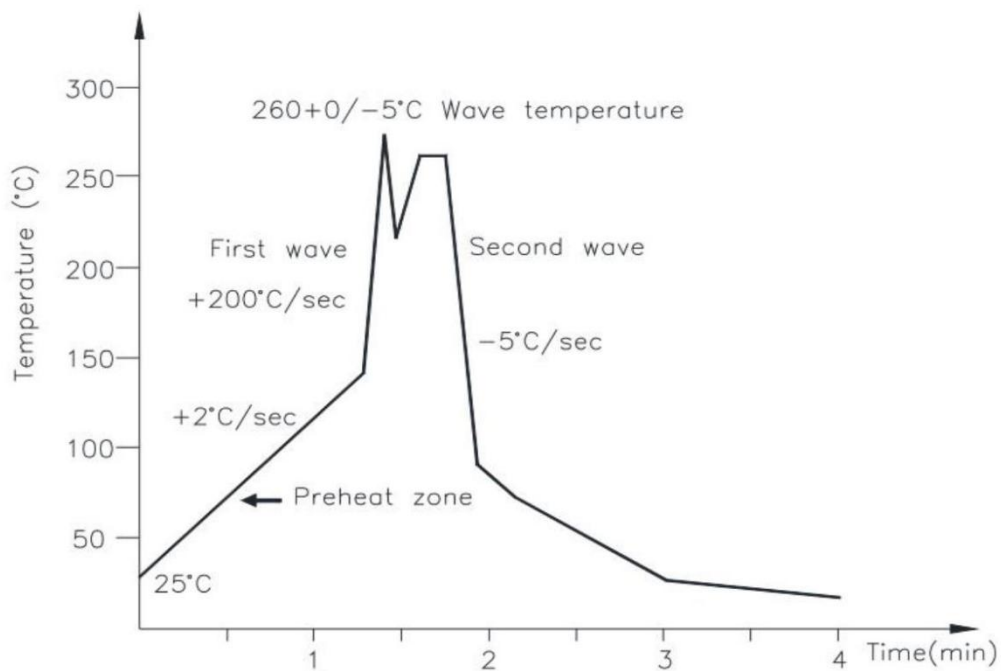

(3).Hand soldering by soldering iron

Allow single lead soldering in every single process. One time soldering is recommended.

Temperature	380+0/-5°C
Time	3 sec max

10.RRECOMMENDED FOOT PRINT PATTERNS (MOUNT PAD)

Unit: mm

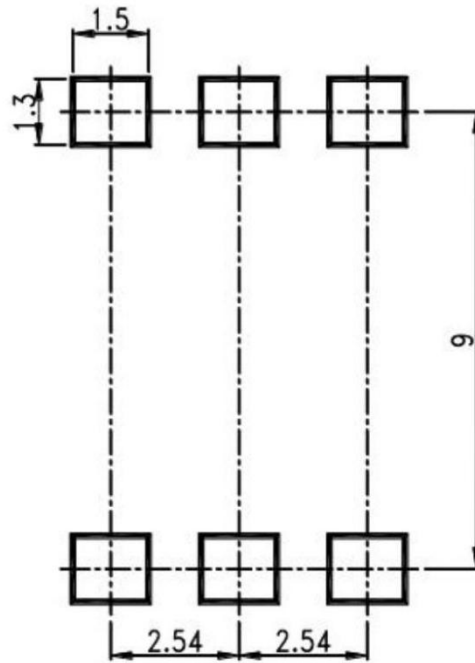

11. CHARACTERISTICS CURVES (TYPICAL PERFORMANCE)

Fig.1 Forward Current vs. Ambient Temperature

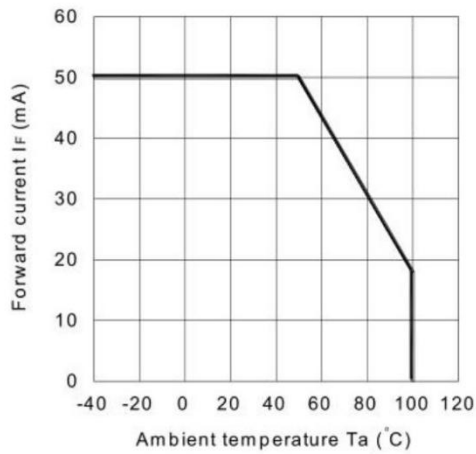

Fig.2 On-state Current vs. Ambient Temperature

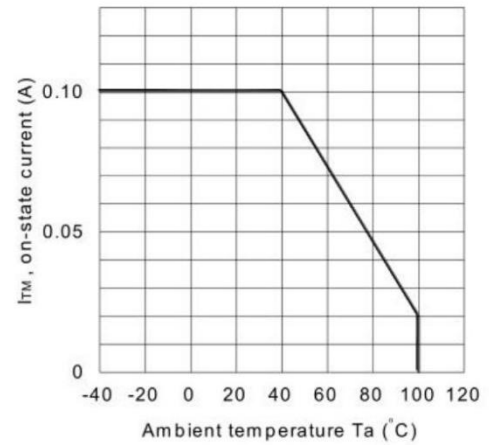

Fig.3 Minimum Trigger Current vs. Ambient Temperature

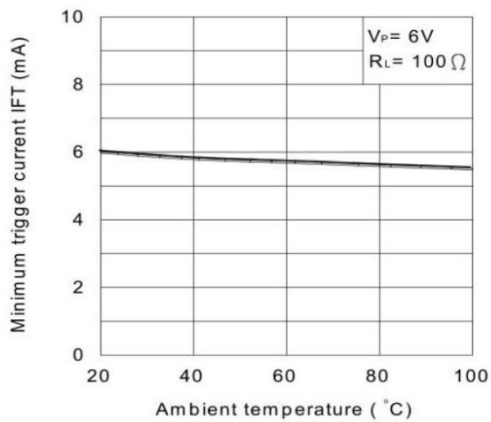

Fig.4 Forward Current vs. Forward Voltage

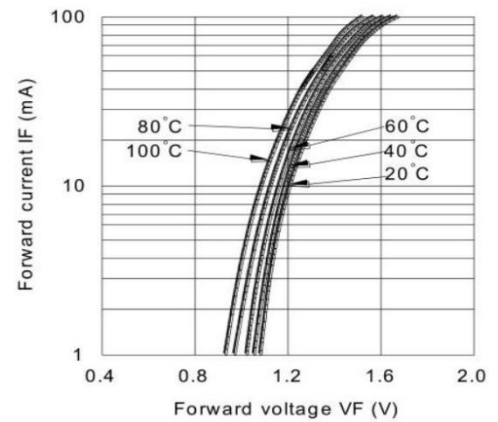

Fig.5 On-state Voltage vs. Ambient Temperature

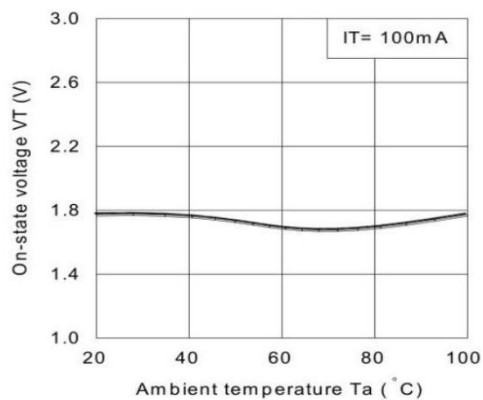

Fig.6 Holding Current vs. Ambient Temperature

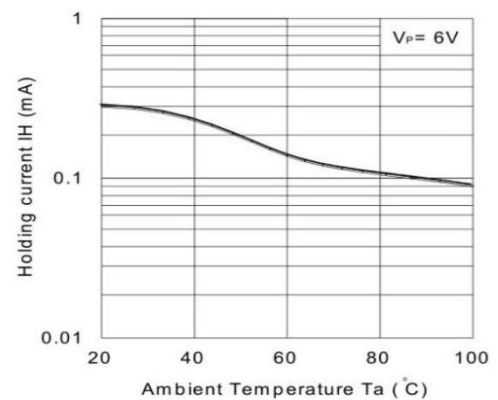

Fig.7 Repetitive Peak Off-state Current vs. Temperature

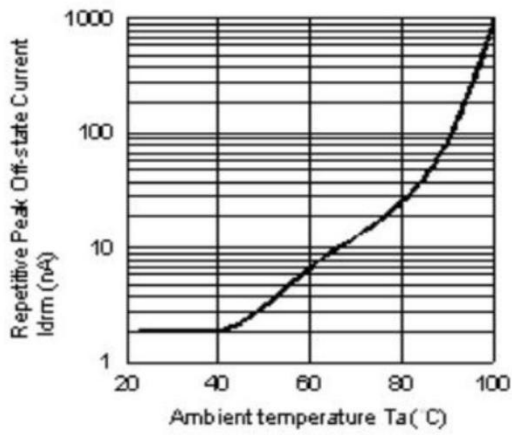
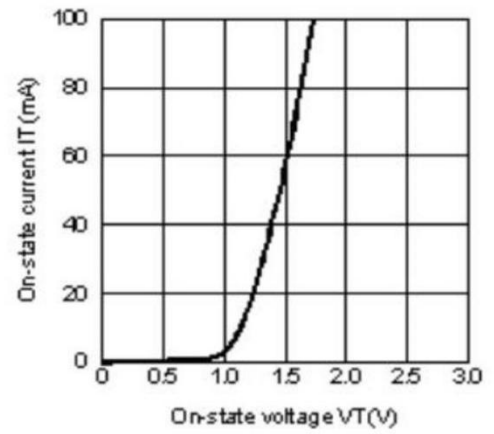

Fig.8 On-state Current vs. On-state Voltage



Basic Operation Circuit

Medium/High Power Triac Drive Circuit

